

Check valve

Type S

RE 20378

Edition: 2017-10

Replaces: 2016-08



- ▶ Size 6 ... 30
- ▶ Component series 1X
- ▶ Maximum operating pressure 450 bar
- ▶ Maximum flow 450 l/min

Features

- ▶ For threaded connection (screw-in thread)
- ▶ Leak-free blocking in one direction
- ▶ Various cracking pressures, optional

Contents

| | |
|-----------------------|------|
| Features | 1 |
| Ordering code | 2 |
| Symbols | 2 |
| Technical data | 3 |
| Characteristic curves | 4, 5 |
| Dimensions | 6 |
| Further information | 7 |

Ordering code

| | | | | | | | | |
|----------|----|----------|----------|-----------|----------|----------|----|----|
| 01 | 02 | 03 | 04 | 05 | 06 | 07 | 08 | 09 |
| S | | A | - | 1X | / | J | | |

| | | |
|----|---------------------|-----------|
| 01 | Isolator valve | S |
| 02 | Size 6 | 6 |
| | Size 8 | 8 |
| | Size 10 | 10 |
| | Size 15 | 15 |
| | Size 20 | 20 |
| | Size 25 | 25 |
| | Size 30 | 30 |
| 03 | Threaded connection | A |

Cracking pressure (see characteristic curves page 4 and 5)

| | | |
|----|--|------------|
| 04 | 0 bar (without spring) | 00 |
| | 0.2 bar | 02 |
| | 0.5 bar (standard) | 05 |
| | 1.5 bar | 15 |
| | 3.0 bar | 30 |
| | 5.0 bar | 50 |
| | 8.0 bar (NG25 and 30 only) | 80 |
| 05 | Component series 10 ... 19 (10 ... 19: unchanged installation and connection dimensions) | 1X |
| 06 | Maximum operating pressure 420 bar (NG25 and 30) | 420 |
| | Maximum operating pressure 450 bar (NG6 ... 20) | 450 |

Corrosion resistance

| | | |
|----|--|-----------|
| 07 | Improved corrosion protection (240 h salt spray test according to EN ISO 9227) | J3 |
| | High corrosion protection (720 h salt spray test according to EN ISO 9227) | J5 |

Piston bore (orifice in channel B)

| | | |
|----|----------------------------|----------------|
| 08 | Without piston bore | no code |
| | Thread M4; not fitted | B00 |
| | Orifice Ø 1.0 mm | B10 |
| | Orifice Ø 1.2 mm | B12 |
| | Orifice Ø 1.5 mm | B15 |

Connection thread

| | | |
|----|---|----------------|
| 09 | Pipe thread "G" according to ISO 228-1 | no code |
| | Pipe thread "M" according to ISO 261 | /2 |
| | Pipe thread "UNF/UN" according to ANSI/ASME B 1.1 | /12 |
| | More thread designs upon request | |

Symbols

Without spring



With spring



With piston bore/orifice

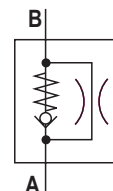

Technical data

(For applications outside these parameters, please consult us!)

| general | | | | | | | | |
|---------|----|-----|-----|-----|-----|-----|-----|-----|
| Sizes | NG | 6 | 8 | 10 | 15 | 20 | 25 | 30 |
| Weight | kg | 0.1 | 0.2 | 0.3 | 0.5 | 1.0 | 2.0 | 2.5 |

| hydraulic | | | |
|---|---------------|--------------------|--|
| Maximum operating pressure ¹⁾ | ▶ NG6 ... 20 | bar | 450 |
| | ▶ NG25 and 30 | bar | 420 |
| Cracking pressure | | bar | see characteristic curves page 4 and 5 |
| Maximum flow | | | see characteristic curves page 4 and 5 |
| Hydraulic fluid | | | see table below |
| Hydraulic fluid temperature range | | °C | -30 ... +80 |
| Viscosity range | | mm ² /s | 2.8 ... 500 |
| Maximum admissible degree of contamination of the hydraulic fluid cleanliness class according to ISO 4406 (c) | | | Class 20/18/15 ²⁾ |
| MTTF _D values according to EN ISO 13849 | | Years | 150 (for further details see data sheet 08012) ³⁾ |

| Hydraulic fluid | Classification | Standards | Data sheet |
|------------------------------|----------------------------------|---|------------|
| Mineral oils | HL, HLP, HLPD, HVLP, HVLPD | DIN 51524 | 90220 |
| Bio-degradable ⁴⁾ | ▶ insoluble in water | HETG HEES | 90221 |
| | ▶ soluble in water | HEPG | |
| Flame-resistant | ▶ water-free | HFDU (glycol base) HFDU (ester base) ⁴⁾ | 90222 |
| | ▶ containing water ⁴⁾ | HFC (Fuchs Hydrotherm 46M, Petrofer Ultra Safe 620) | 90223 |



Important information on hydraulic fluids:

- ▶ For further information and data on the use of other hydraulic fluids, please refer to the data sheets above or contact us.
- ▶ There may be limitations regarding the technical valve data (temperature, pressure range, life cycle, maintenance intervals, etc.).
- ▶ The ignition temperature of the hydraulic fluid used must be 50 K higher than the maximum surface temperature.

▶ Flame-resistant – containing water:

- Life cycle as compared to operation with mineral oil HL, HLP 30 ... 100%
- Maximum hydraulic fluid temperature 60 °C

¹⁾ Maximum operating pressures up to 1000 bar upon request.

²⁾ The cleanliness classes specified for the components must be adhered to in hydraulic systems. Effective filtration prevents faults and simultaneously increases the life cycle of the components.

For the selection of filters, see www.boschrexroth.com/filter.

³⁾ Not for version "00"; Certificate "Assumed exclusion of faults according to EN ISO 13849-2:2012-10 tab. C4" available upon request.

⁴⁾ Small amounts of dissolved zinc may get into the hydraulic system during use.

Characteristic curves

(measured with HLP46, $\vartheta_{oil} = 40 \pm 5 \text{ }^\circ\text{C}$)

Δp - q_v characteristic curves at cracking pressure

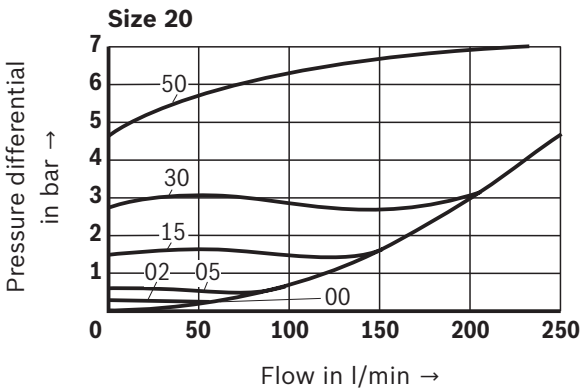
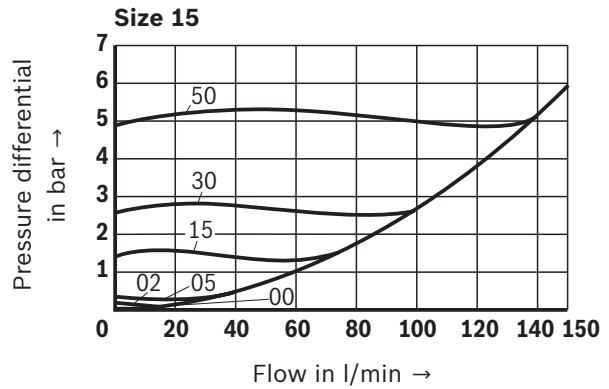
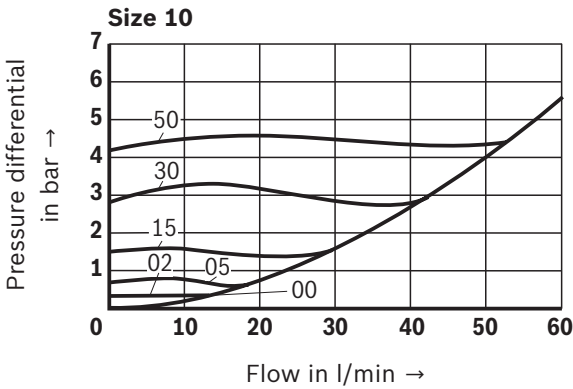
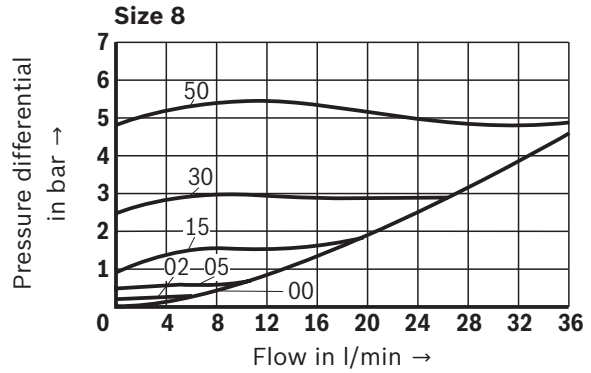
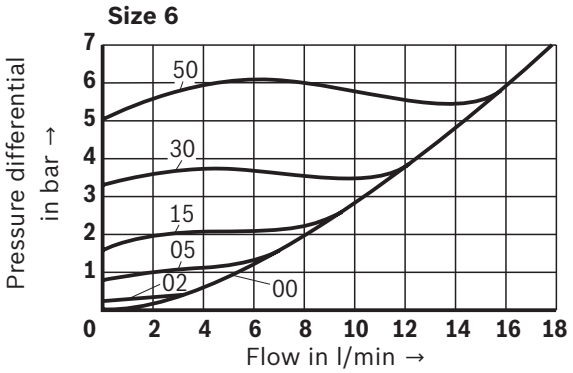

- 00 Cracking pressure 0 bar (without spring)
- 02 Cracking pressure 0.2 bar
- 05 Cracking pressure 0.5 bar (standard)
- 15 Cracking pressure 1.5 bar
- 30 Cracking pressure 3.0 bar
- 50 Cracking pressure 5.0 bar

Characteristic curves

(measured with HLP46, $\vartheta_{oil} = 40 \pm 5 \text{ } ^\circ\text{C}$)

Δp - q_V characteristic curves at cracking pressure

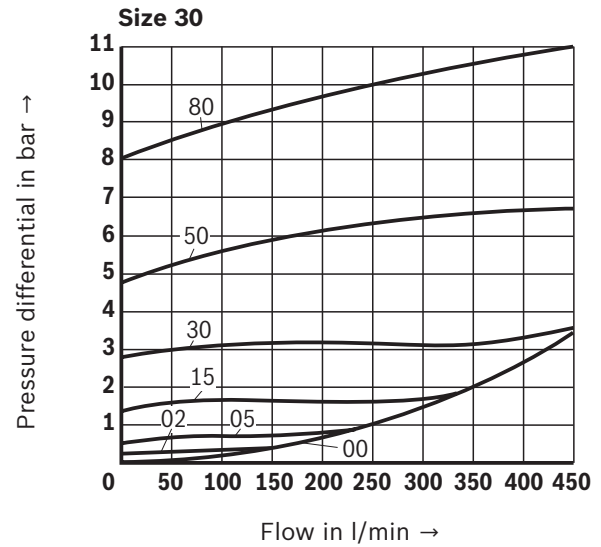
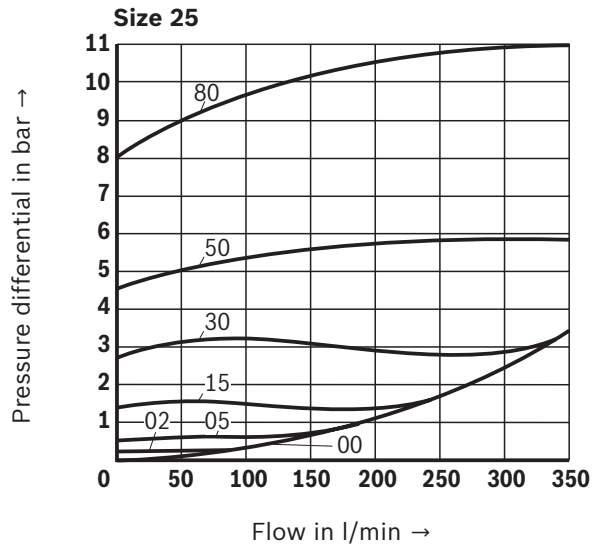

- 00** Cracking pressure 0 bar (without spring)
- 02** Cracking pressure 0.2 bar
- 05** Cracking pressure 0.5 bar (standard)
- 15** Cracking pressure 1.5 bar
- 30** Cracking pressure 3.0 bar
- 50** Cracking pressure 5.0 bar
- 80** Cracking pressure 8.0 bar

Dimensions

(dimensions in mm)

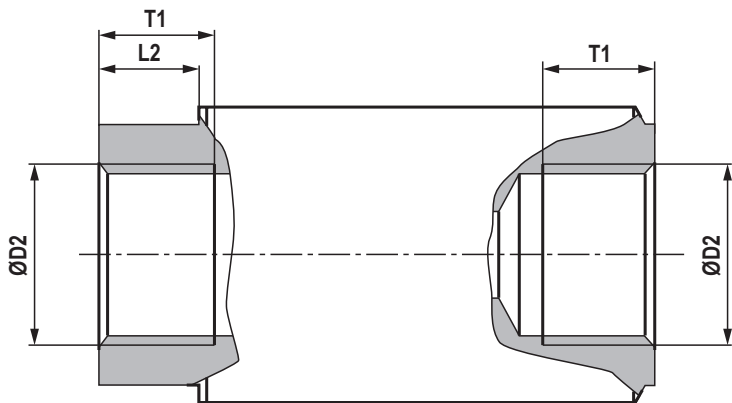
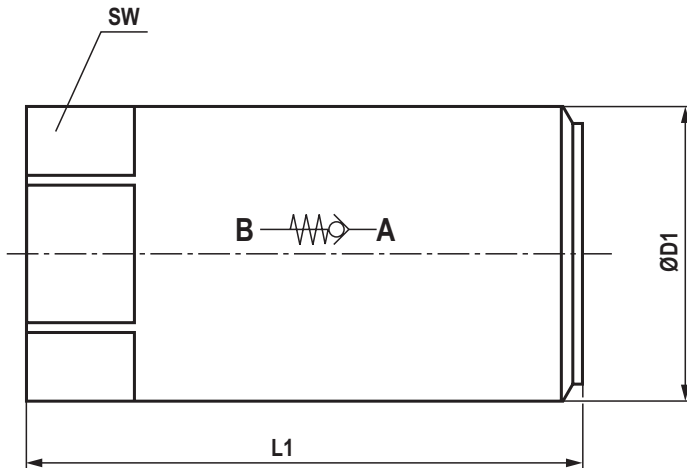

| | Size | | | | | | | | |
|-------------------------|----------|-----------|-----------|------------|------------|-------------|-------------------|-------------------|-------------|
| | 6 | 8 | 10 | 15 | 20 | 25 | 30 | | |
| ØD1 | 22.5 | 28 | 34 | 34 | 42 | 52 | 68 | 74.5 | |
| D2 | "G" | G1/4 | G3/8 | - | G1/2 | G3/4 | G1 | G1 1/4 | G1 1/2 |
| | "M" | M14 x 1.5 | M18 x 1.5 | - | M22 x 1.5 | M27 x 2 | M33 x 2 | M42 x 2 | M48 x 2 |
| | "UNF/UN" | - | - | 3/4-16 UNF | 3/4-16 UNF | 1 1/6-12 UN | 1 5/16-12 UN | 1 5/8-12 UN | 1 7/8-12 UN |
| L1 | "G" | 58 | 58 | - | 72 | 88 | 98 | 120 | 132 |
| | "M" | 58 | 58 | - | 72 | 88 | 98 | 120 | 132 |
| | "UNF/UN" | - | - | 66 | 72 | 92 | 105 | 120 | 132 |
| L1 ¹⁾ | - | - | - | - | - | - | 160 ¹⁾ | 168 ¹⁾ | |
| L2 | 10.5 | 11.5 | 13 | 13 | 15.5 | 19 | 25 | 28 | |
| | "G" | 13 | 13 | - | 15 | 18 | 19 | 22 | 22.5 |
| T1 | "M" | 12 | 12 | - | 14 | 16 | 18 | 20 | 22 |
| | "UNF/UN" | - | - | 15 | 15 | 20 | 20 | 20 | 20 |
| SW | 19 | 24 | 30 | 30 | 36 | 46 | 60 | 65 | |

¹⁾ Version "...A80..."